

Epoque, cyclical *light*.

design Stefano Papi & Saviz Yaghmai
terzani.com

TERZANI
LA LUCE PENSATA



Product Name
Epoque
vertical chandelier

Materials
brass chains | metal
structure plated as below



Finishes | Code

-  nickel
OG91S E7 C8
-  black nickel
OG91S E9 C8
-  bronze
OG91S F7 C8
-  gold plated
OG91S L6 C8

Body

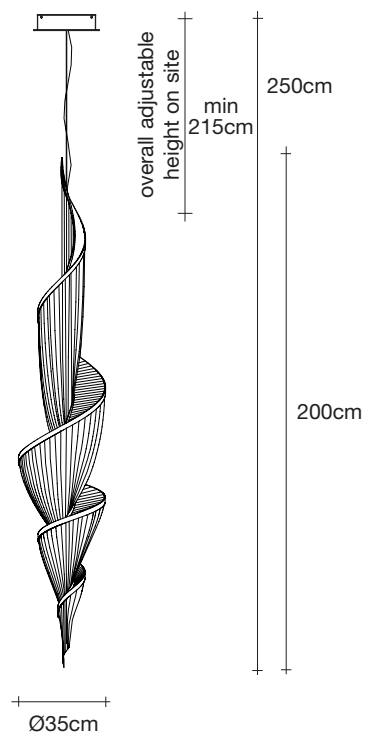

Light source
230-240V ~ 50/60Hz

-  Built in Replaceable LED Module
12 x 2,1W 2328 lm 3000K
or optional 2064 lm 2700K

dimnable options

-  0/1-10V
PUSH
DALI

Canopy

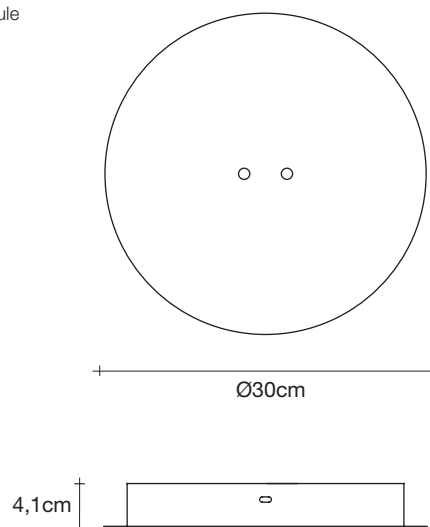

Epoque is a light sculpture designed to study chiaroscuro and volumes. The result is a modern expression of these Renaissance-era techniques in a stunning chandelier. Composed of curved, organic lines, Epoque's frame is made of flexible and durable brass metal, suspended by nickel metal chains. Two bands of metal, a central elongated section and an external band of wide arcs, allows the light to envelop a room in reflections of soft light. Epoque has attracted attention from those in the design community with discerning tastes. Epoque is available in nickel, black nickel and gold finish. Design Stefano Papi & Saviz Yaghmai.

Epoque, cyclical *light*.

design Stefano Papi & Saviz Yaghmai
terzani.com



Product Name





Epoque
chandelier

Materials

brass chains | metal
structure plated as below



Finishes | Code

-  nickel
OG90S E7 C8
-  black nickel
OG90S E9 C8
-  bronze
OG90S F7 C8
-  gold plated
OG90S L6 C8

Overall height not adjustable on site
optional custom OAH

Body

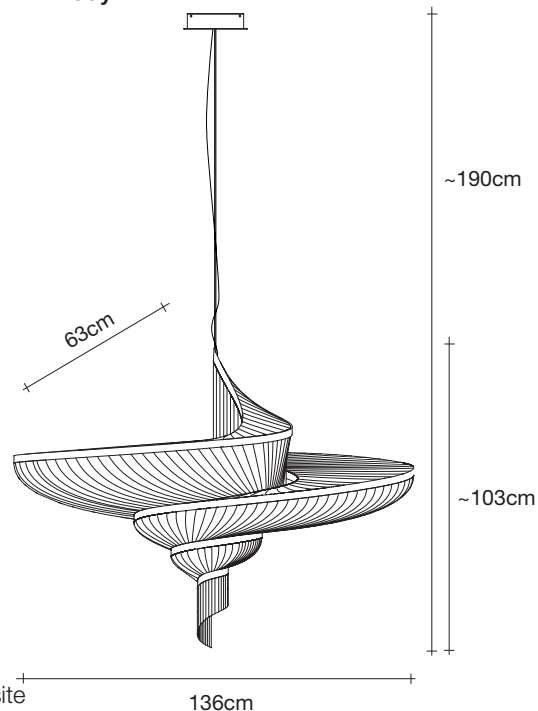

Light source

230-240V ~ 50/60Hz

- Built in Replaceable LED Module
20 x 2,1W 3880 lm 3000K
or optional 3440 lm 2700K

dimnable options

- PUSH
DALI

Canopy

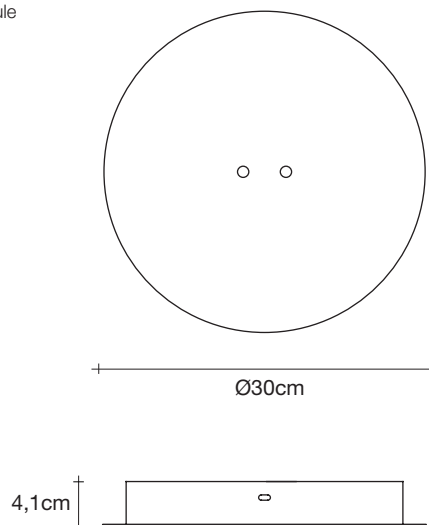

Epoque is a light sculpture designed to study chiaroscuro and volumes. The result is a modern expression of these Renaissance-era techniques in a stunning chandelier. Composed of curved, organic lines, Epoque's frame is made of flexible and durable brass metal, suspended by nickel metal chains. Two bands of metal, a central elongated section and an external band of wide arcs, allows the light to envelop a room in reflections of soft light. Epoque has attracted attention from those in the design community with discerning tastes. Epoque is available in nickel, black nickel and gold finish. Design Stefano Papi & Saviz Yaghmai.